

RLX 355

Parts Guide



<u>Category</u>	<u>Page Number</u>
Electrical Cabinet	2-3
Motor's, Cable's & Drives	4-5
Switches & Buttons	5-6
Handwheel & Jog Stick	6-7
Pendant & Module	7
Pumps	6
Other Electrical Parts	7-8
Pneumatic & Coolant	9
Main Door & Windows	9-10
Belt's	10
Drag Chain & Wipers	11
Tooling Inc Chucks/Toolpost/ Steady & Drilling Attachment	11-13

Electrical Cabinet

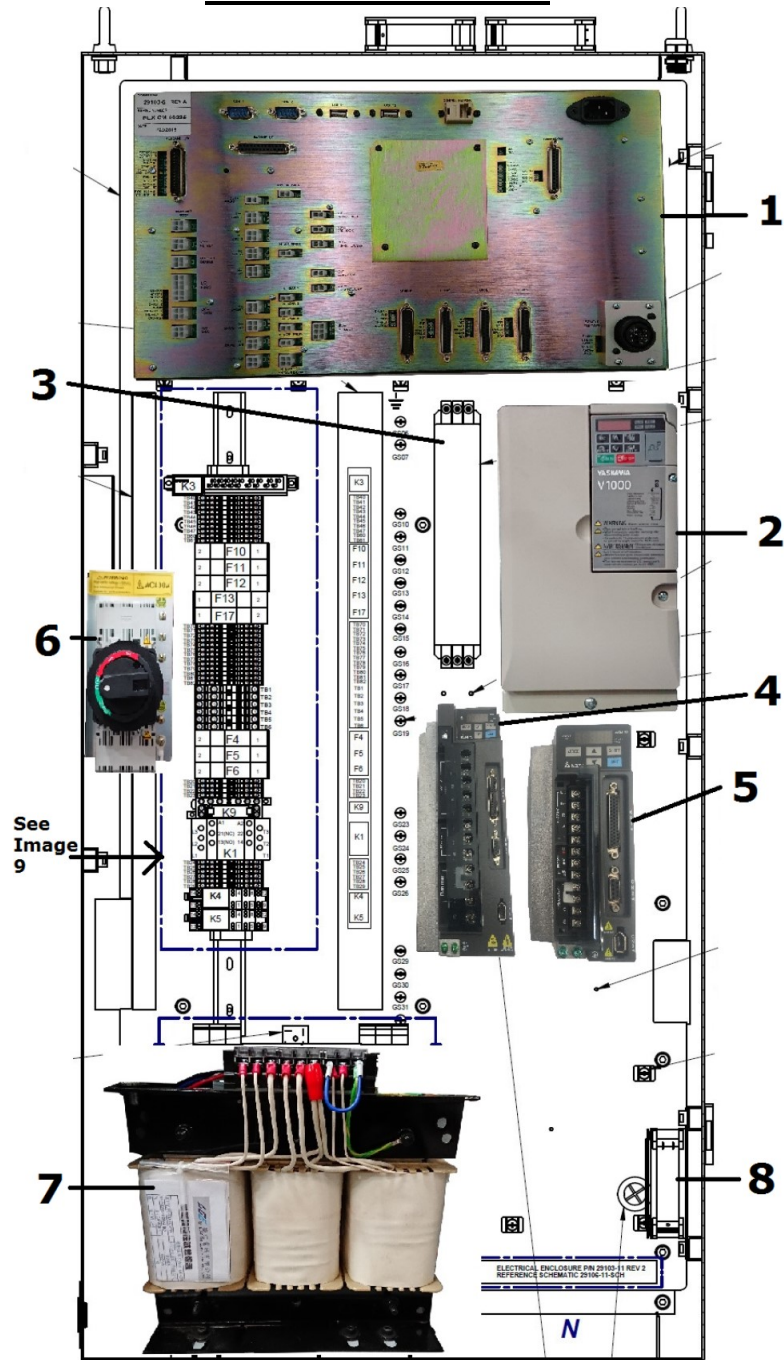

<u>Item</u>	<u>Description</u>	<u>XYZ Part</u>
1	RLX Computer Module	17404
2	Inverter 5.5 KW	5870
3	Schaffner Line Filter	16782
4	Delta Servo Driver 750W	17609
5	Delta Servo Driver 2KW	17619
6	Door Isolator Switch 30A	14685
7	Transformer 3 Phase	17231
8	115V Fan	14128

Image 9

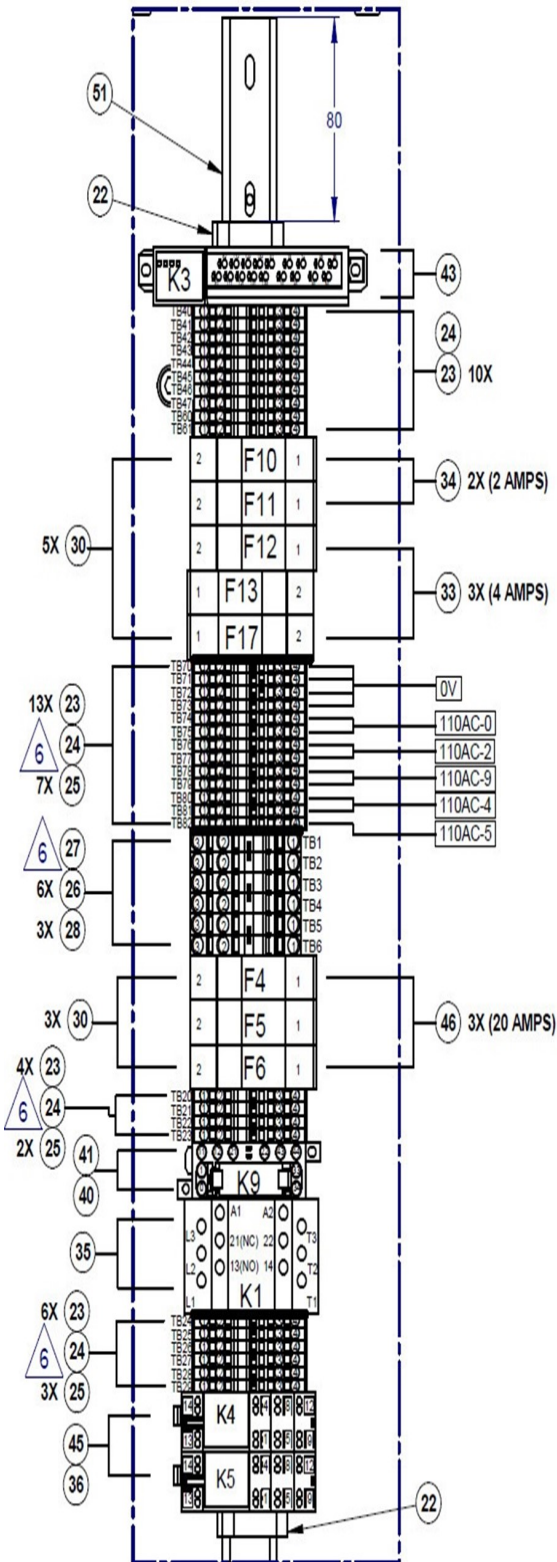

<u>Item Number</u>	<u>Description</u>	<u>XYZ Part Number</u>
22	Terminal Block End Cap	10376
23	Terminal Block Din Rail 20A	15168
24	Terminal Block Cover 20A	15167
25	Terminal Block Jumper 20A	15166
26	Terminal Block Din Rail 3 Pos 41A	17699
27	Terminal Block End Cover	17705
28	Terminal Block Jumper 41A	17260
29	Fuse 10 x 38mm 12 Amp	14088
30	Fuse Holder 32A	3750
32	Fuse 10 x 38mm 16 Amp	3147
33	Fuse 10 x 38mm 4 Amp	6622
34	Fuse 10 x 38mm 2 Amp	6616
35	Contactory Relay 24v DC	17337
36	Relay Socket 2 Pole Push Fit	16271
40	Omron Safety Relay	13767
41	Omron Socket Din Rail 4 Pole	13768
43	Omron Safety Relay 401 24V DC	15052
45	Omron Relay 2P 24VDC	16270
46	Fuse 10 x 38mm 20 Amp	6620
51	Din Rail	1655

Motor's, Cable's & Drives

<u>Description</u>	<u>XYZ Part Number</u>	
X Axis Motor	13639	
Z Axis Motor	17647	
X Axis Drive	17609	
Z Axis Drive	17619	
X Axis Motor Encoder Cable	17417	
X Axis Motor Power Cable	17416	
Z Axis Motor Encoder Cable	17186	
Z Axis Motor Power Cable	17418	



Motor's, Cable's & Drives

<u>Description</u>	<u>XYZ Part Number</u>	
Main Spindle Motor	7730	



Switches & Buttons

<u>Description</u>	<u>XYZ Part Number</u>	
E-Stop Button	3132	
Main Door / Belt Inspection Door Switch	3219	
Chuck Guard Switch	3351	
Limit Switch Fits Both X Or Z	16402	
Apron Cycle Start Button	15008	



Switches & Buttons

<u>Description</u>	<u>XYZ Part Number</u>	
Door Isolator Switch	14685	
Gear Selector Sensor Switches	7923	

Pump's

<u>Description</u>	<u>XYZ Part Number</u>	
Coolant Pump 110V 6" Pick Up	1825	
AutoLube Pump 110V YET-F1	10637	

Handwheel's & Jog Stick

<u>Description</u>	<u>XYZ Part Number</u>	
Safety Jog Stick	15012	
X Axis Handwheel	465	



Handwheel's & Jog Stick

<u>Description</u>	<u>XYZ Part Number</u>	
Z Axis Handwheel	6932	

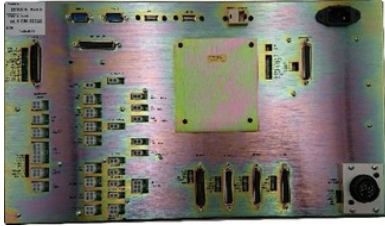
Pendant & Module

<u>Description</u>	<u>XYZ Part Number</u>	
RLX Pendant	17394	
Computer Module	17404	



Other Electrical Parts

<u>Description</u>	<u>XYZ Part Number</u>	
Inverter 5.5KW	5870	
Main Transformer	17231	



Other Electrical Parts

<u>Description</u>	<u>XYZ Part Number</u>	
Brake Resistor	5967	
Spindle Encoder	17253	
Work Lamp 24V	17367	
Work Light	15823	
Spindle Motor Fan	6439	
Electronic Handwheel & Apron Jog Stick Cable	460	

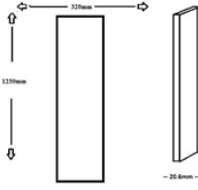

Pneumatic & Coolant

<u>Description</u>	<u>XYZ Part Number</u>	
Air Regulator Unit	4915	
Tailstock Assembly Air Pipe	2196	
Coolant Nozzle Assembly	12585	
Armoured Coolant Pipe 180"	4729	





Main Door & Window's

<u>Description</u>	<u>XYZ Part Number</u>	
Door Spring	8347	
Main Window 1230 x 320mm	15031	
Window Silicon	11661	



Pneumatic & Coolant

<u>Description</u>	<u>XYZ Part Number</u>	
Perspex Panel Tailstock End 470 x 332mm	7765	
Perspex Panel Auto Lube Pump	16711	



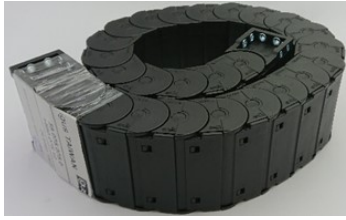

Belt's

<u>Description</u>	<u>XYZ Part Number</u>	
X Axis Belt	778	
Z Axis Belt	17116	
Spindle Encoder Belt	12875	
Spindle Belt Set	7865	
Spindle To Gear box Belt Set	7802	



Drag Chain / Wiper's

<u>Description</u>	<u>XYZ Part Number</u>	
Z Axis Chain	17542	
Wiper Kit	9794	



Chuck's

<u>Description</u>	<u>XYZ Part Number</u>	
Standard 200mm Scroll 3 Jaw Chuck Supplied With The Machine	3867	
250mm Independent 4 Jaw Chuck Cast Iron	2662	
Chuck Guard To Suit 200mm Chuck	8368	
Chuck Guard To Suit 250mm Chuck	11904	
Soft Jaws For 200mm 3 Jaw Chuck	2645	

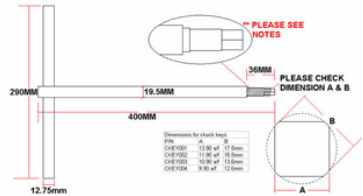
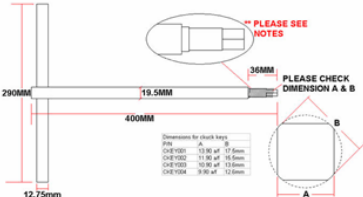

Chuck's

<u>Description</u>	<u>XYZ Part Number</u>	
Hard Inside Solid Jaws To Suit 200mm 3 Jaw	1344	
Hard Outside Solid Jaws To Suit 200mm 3 Jaw	538	
Soft Jaws For 250mm 4 Jaw Chuck	12458	
Extended Chuck Key For 200mm Chuck	6163	
Extended Chuck Key For 250mm Chuck	4462	

Steady Options

<u>Description</u>	<u>XYZ Part Number</u>	
Fixed Steady 20-155mm	7024	
Travelling Steady 15-70mm	7039	

Tool Post / Holders

<u>Description</u>	<u>XYZ Part Number</u>	
T2T Quick Change Tool Post Set	4929	
T2T Standard Holder	4938	
T2T Vee Holder	4939	
T2T Morse Holder	4940	
T2T Plain Bore 32mm Holder	4943	

Drilling Attachment's

<u>Description</u>	<u>XYZ Part Number</u>	
Drilling Attachment 40mm Bore	7725	